



Sink - Tara.

Three-hole lavatory mixer with drain - polished chrome

Article number: 20 710 882-00 0010



- 5-3/8" Projection
- US drain with overflow
- Swiveling spout 360°
- Round aerated stream
- Total height 10-5/8"
- Height to aerator/spout outlet 6-3/8"
- Valve hole diameter 1-1/4"
- Spout hole diameter 1-3/8"
- Flange diameter 2-1/8"
- Water flow rate limited to max. 1.2 gpm
- lead-free
- (ADA)
- Suitable only for basins with overflow.

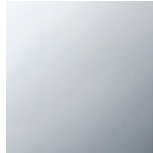

polished chrome





Sink - Tara.

Three-hole lavatory mixer with drain - polished chrome

Article number: 20 710 882-00 0010

Dimensional drawing

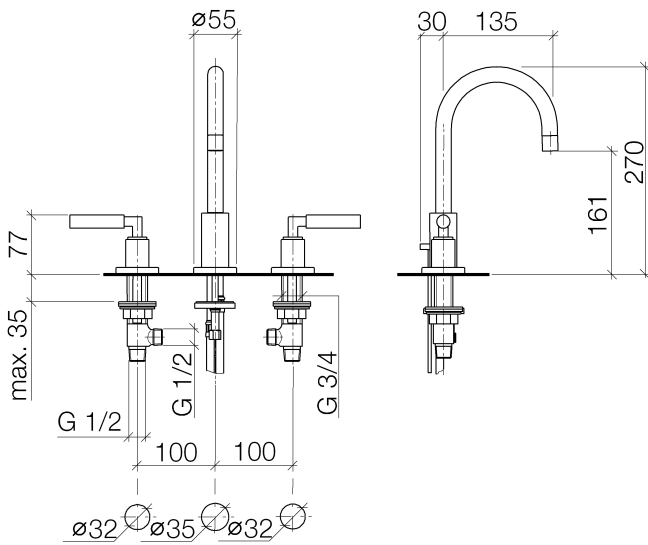

All dimensions in mm / inch = mm x 0,0394

Flow rate chart

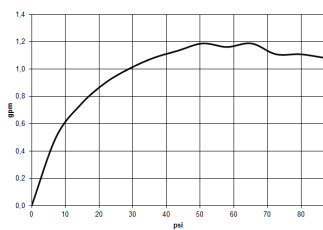



Sink - Tara.

Three-hole lavatory mixer with drain - polished chrome

Article number: 20 710 882-00 0010

Other surface finishes



platinum matte
20 710 882-06 0010



platinum
20 710 882-08 0010



Dark Brass matte
20 710 882-16 0010



Dark Bronze matte
20 710 882-17 0010



black matte
20 710 882-33 0010



Dark Platinum matte
20 710 882-99 0010

More custom finish options are available via special production (xTra Service). Please see our finish matrix for availability and pricing or contact a Dornbracht representative.

Spare parts list

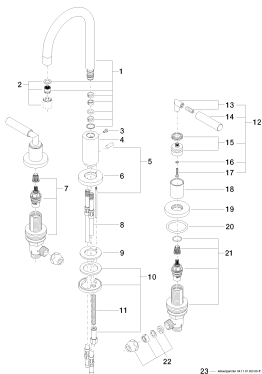

Number	Item Number	Designation	Number of units
--------	-------------	-------------	-----------------